

 This luminaire contains built-in LED lamps.

The lamps cannot be changed in the luminaire

smartwares® FCL-76006 874/2012

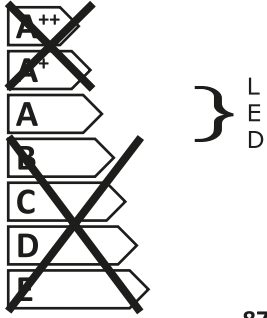

 Diese Leuchte enthält eingebaute LED-Lampen.

Die Lampen können in der Leuchte nicht ausgetauscht werden.

smartwares® FCL-76006 874/2012

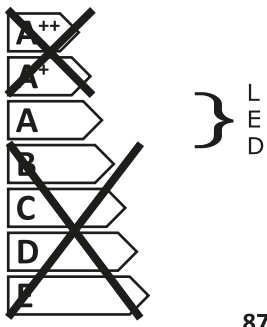

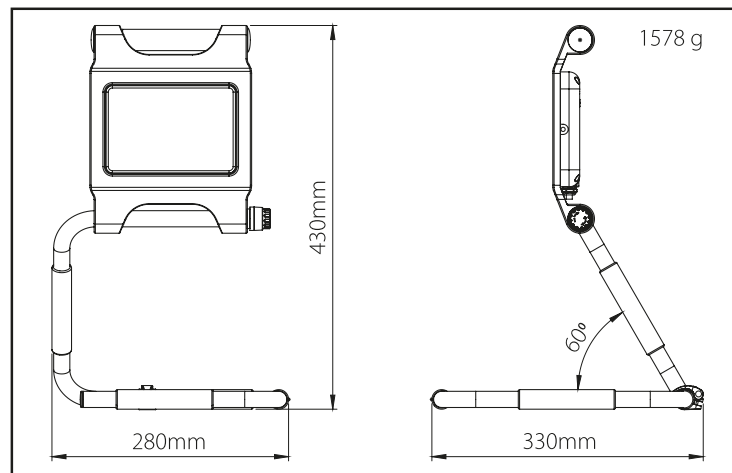

|   |                         |  |
|---|-------------------------|--|
| <b>smartwares® Europe</b><br>Jules Verneweg 87<br>5015 BH Tilburg<br>The Netherlands<br>service.smartwares.eu | NL: 088 5940501         | Lokaal tarief                                    |
|   | BE: 078 481094(NL)      | Lokaal tarief                                    |
|   | BE: 078 481540(FR)      | Tarif local                                      |
|   | FR: 0825 560 650        | 18ct/min   |
|   | DE: +49 (0) 1805 010762 | 14Ct./Min. dt. Festnetz,<br>Mobil max. 42Ct./Min |
| UK: +44 (0) 345 230 1231  |                         |  |
| ES: +34 938427589   |                         |  |

CUSTOMER SERVICE

IP65   

 smartwares®



16  
WATT

1200  
LUMEN

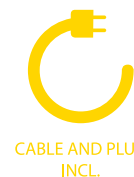

# Foldable LED work light

DE LED Arbeitsleuchte IT Lampada da lavoro LED  
 NL Opvouwbare LED kluslamp FR Projecteur de chantier LED  
 ES Luz LED de trabajo TR Seyyar LED projektör PT Candeeiro LED de trabalho

FCL-76006

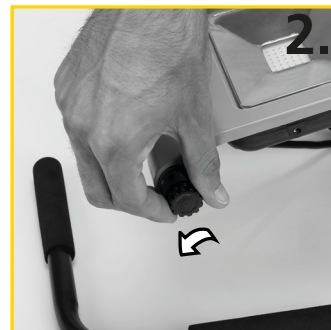
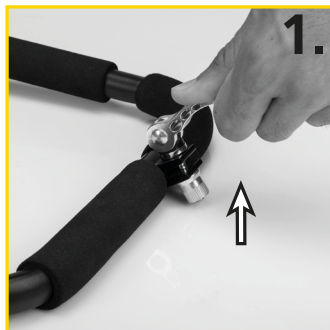

|                        |                              |   |                           |
|------------------------|------------------------------|---|---------------------------|
| <b>30 WATT LED</b>     | <b>2250 LUMEN</b>            | <b>CABLE LENGTH: 1.8 METER (HO5RN-F 3G1.0MM2)</b> | <b>NON DIMMABLE</b>       |
| <b>0s</b>              | <b>NATURAL WHITE ± 4000K</b> | <b>ON OFF 15.000X</b>                             | <b>25.000 H</b>           |
| <b>120° BEAM ANGLE</b> | <b>IP65</b>                  | <b>RA&gt;70</b>                                   | <b>220-240V ~ 50/60Hz</b> |
| <b>1m</b>              |                              |   |                           |

**IP65**

- GB** The lamp is dust-proof and spray-proof.
- NL** Het armatuur is stofdicht en spuitwaterdicht.
- F** L'armature ne laisse pas passer la poussière et est étanche aux projections d'eau.
- D** Die Armatur ist staubdicht und sprühwasserdicht.
- N** Armaturet er beskyttet mot støv og sprut.
- S** Armaturen är dammtät och tät mot vattenstrålar.
- DK** Armaturet er støvtæt og sprøjtetæt.
- FIN** Valaisin on pölytiivis ja suihkuvedenpitävä.
- PL** Urządzenie jest pyłoszczelne i odporne na rozpylaną ciecz.
- RUS** Осветительная арматура является пыле и водонепроницаемой
- BG** Осветителното тяло е устойчиво на прах и пръски.
- H** A szerelvény por- és permetálló.
- RO** Corpul de iluminat este rezistent la praful și pulverizare.
- SK** Svietiljka je zaštiãena protiv prašine i raspršene vode.
- HR** Zariadenie je chránené proti prachu a rozprašovanej vode.
- CZ** Zařízení je chráněno proti prachu a rozprašované vodě.
- SLO** Nosilec je odporen proti prahu in pršenju.
- I** La lampada è a tenuta di polvere e protetta contro il gocciolamento.
- P** A ferragem de conexão é a prova de poeira e vaporizações.
- E** El montaje está protegido contra polvo y rociado.
- GR** Η εφαρμογή αντέχει στη σκόνη και είναι αδιάβροχη στον ψεκασμό
- TR** Tertibat toz ve püskürtülene karşy dayanıklıdır.